

Return To: American Pool Inc.
 Email To: americanleaksquad@gmail.com
 Phone: _____

DEALER IS RESPONSIBLE FOR THE PROPER FIT!

By the submission of this order, the below named corporation and individual hereby authorize American Pool Inc. to manufacture as a special order, a vinyl liner for an inground pool in accordance with the design and specifications which have been provided here within, and hereby acknowledge that American Pool Inc. has not participated in either the design or formation of this liner and accepts full responsibility for the same, and further agrees to hold American Pool Inc. harmless, that is, the below named corporation will pay in full or for any and all claims and expenses that may arise out of the design for use of this special liner.

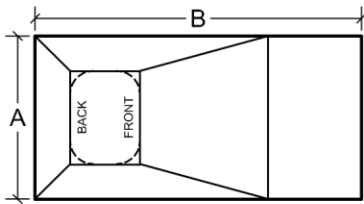

RECTANGLE
 Do you have Radius Hopper Corners?

FRONT _____ IN
 HOPPER RAD.
 BACK _____ IN
 HOPPER RAD.

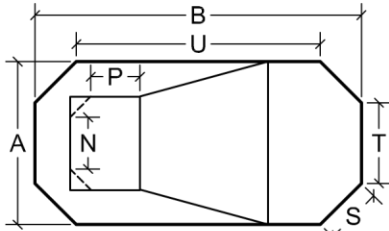

GRECIAN
 Hopper Shape
 Contour
 Square

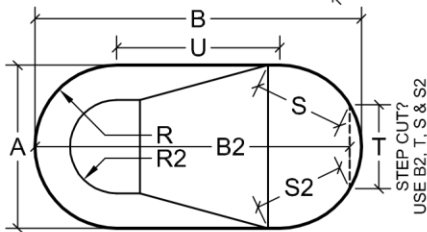

OVAL
 Hopper Shape
 Contour
 Square

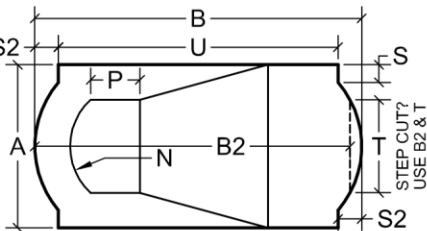

ROMAN END DBL SGL

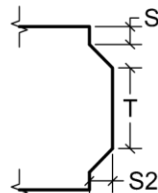

BOWED END

SELECT POOL CORNER TYPE

SQUARE

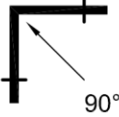

RADIUS

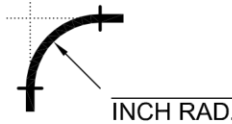

DIAGONAL



Company: _____
 Address: _____
 CITY _____ STATE _____ ZIP _____
 Phone: () _____
 Ordered By: _____
 PO # _____
 Date: _____

SHIPPING INSTRUCTIONS

Company: _____
 Address: _____
 CITY _____ STATE _____ ZIP _____
 Phone: () _____
 Mark Box: _____
 Ship Via: _____

FINISHED DIMENSIONS

YOU MUST PROVIDE A DIMENSION FOR THE CORRESPONDING LETTER

A	FT	IN	G	FT	IN	J	FT	IN	R	FT	IN
B	FT	IN	H	FT	IN	K	FT	IN	R2	FT	IN
B2	FT	IN	I	FT	IN	L	FT	IN	S	FT	IN
D	FT	IN				M	FT	IN	S2	FT	IN
E	FT	IN				M2	FT	IN	T	FT	IN
F	FT	IN							U	FT	IN
SAFETY LEDGE _____ IN									N	FT	IN
COVE OFFSET _____ IN									P	FT	IN
COVE DEPTH _____ IN											

Is the Pool Bottom 'BOWLED' or 'DISHED' out? _____
 If 'YES', supply additional drawings representing the bottom design.

IMPORTANT!

BEAD

Total Square Footage: _____

Yes No _____ in. overlap
 Reverse Esther Williams (large bead)

PATTERN

Wall Pattern: _____
 Floor Pattern: _____
 Vinyl Thickness: 20 Mil 28 Mil 30 Mil

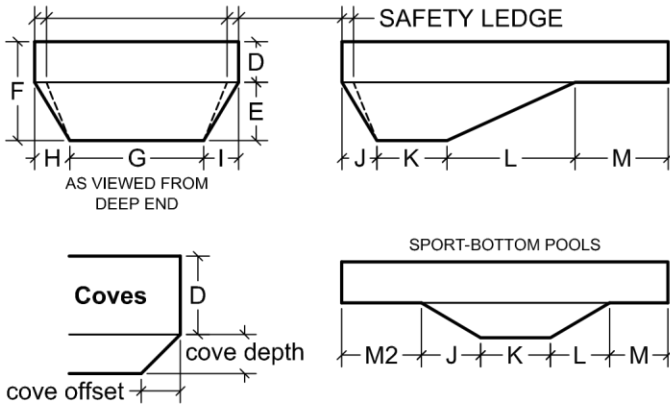

ADDITIONAL INFORMATION ON BACK? Yes No

SOME POOLS ARE NOT BUILT TO MANUFACTURERS SPECS. IT IS IMPORTANT THAT YOU VERIFY THE DIMENSIONS

American Pool Inc. and its authorized distributors and dealers, as part of the swimming pool industry adopt those standards for the purpose of pool safety to prevent the risk of a consumer or guest from suffering a severe or paralyzing injury or loss of life due to diving into water less than prescribed by modern standards. Such injuries can also occur by sliding head first into shallow water. We will produce the liner according to the dimensions provided only upon the following conditions:

- Consumer agrees to permanently remove the diving board if it exists prior to the installing of this liner.
- Consumer agrees to relocated sliding board if necessary, prior to installation of this liner, to conform to APSP standards.
- Consumer agrees to defend, indemnify and hold American Pool Inc. and its distributors and dealers harmless from any claims arising from injuries that may occur from the use of the pool containing this liner.
- Consumer agrees that in addition to abiding to the conditions above, he will not allow use of the pool by anyone, including guests, which is inconsistent with this warning.

I UNDERSTAND THE ABOVE WARNING AND RECOMMENDATIONS, CERTIFY THAT I WILL ABIDE BY ALL PERTINENT CONDITIONS, AND REQUEST THAT YOU PRODUCE THIS LINER AS ORDERED.

YOU MUST SIGN AND RETURN THIS FORM WITHIN 2 BUSINESS DAYS OR IT WILL NOT BE PROCESSED.

Pool Owner Signature _____ DATE _____

IMPORTANT!

**All Pools Are NOT Square!
Diagonal Measurements MUST Be Given ON Lazy-"L" Pools.**

TO PREVENT DELAYS, PLEASE FILL OUT BOTH SIDES OF THIS FORM AS ACCURATELY AS POSSIBLE!

SELECT DIRECTION OF POOL

AS VIEWED FROM THE SHALLOW END

LEFT

RIGHT (SHOWN)

Hopper Shape

Contour
 Square

Do you have Radius Hopper Corners?

BACK IN FRONT IN
HOPPER RAD. HOPPER RAD.

LAZY-"L"

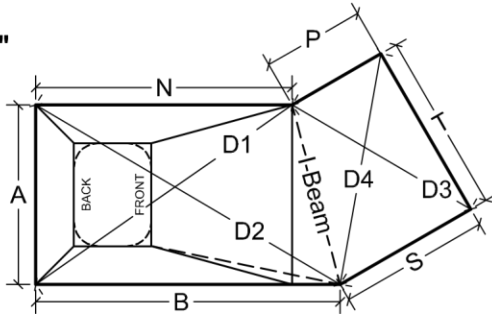

SHALLOW END BREAK LINE:

Follows I-Beam Measurements?
 Perpendicular to B Wall?

TRUE-"L"

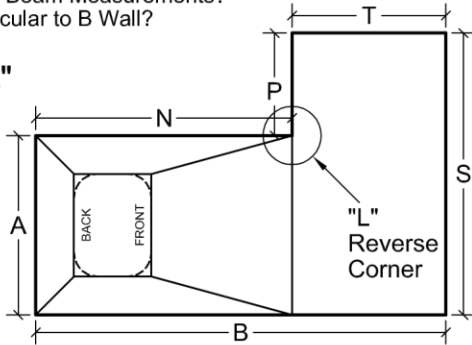

SELECT "L" REVERSE CORNER TYPE

SQUARE

RADIUS

DIAGONAL

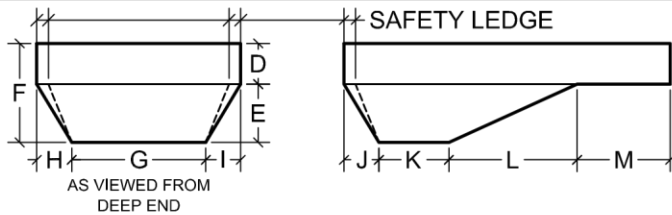

ADDITIONAL POOL SHAPES

IMPORTANT!

IF YOU HAVE ONE OF THE POOLS BELOW, YOU WILL BE REQUIRED TO FILL OUT A POINT-TO-POINT FORM FOR TRUE ACCURACY UNLESS YOU PROVIDE AN ACCURATE MANUFACTURER DIG SPEC.

- KIDNEY
- OASIS
- MARTINIQUE
- FIGURE-8
- TRUE-OVAL
- FREE FORM
- KEYHOLE
- OTHER _____
- TEE
- ROUND
- HEXAGON
- OCTAGON
- DECAGON
- JEWEL

SELECT POOL CORNER TYPE

SQUARE

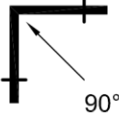

RADIUS

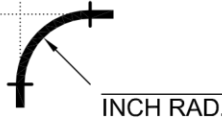

DIAGONAL



VINYL STEP

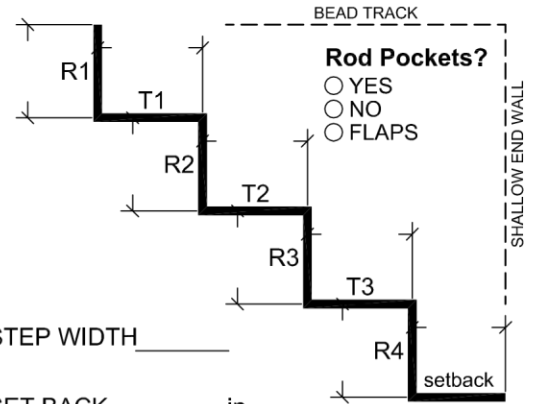

STEP WIDTH _____

SET BACK _____ in.

CIRCLE ONE..... 45° 90°

CORNERS

CIRCLE ONE..... 6"rad. 90° diag. _____

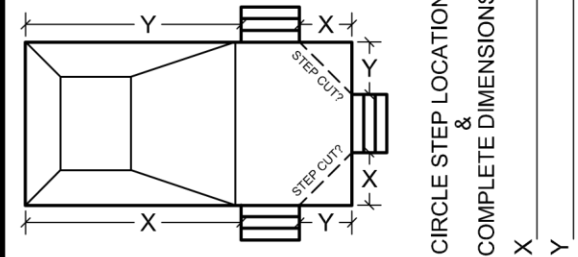

STEP MANUFACTURER: _____

FINISHED DIMENSIONS

YOU MUST PROVIDE A DIMENSION FOR THE CORRESPONDING LETTER

A	FT	IN	D1	FT	IN	G	FT	IN	R	FT	IN
B	FT	IN	D2	FT	IN	H	FT	IN	R2	FT	IN
D	FT	IN	D3	FT	IN	I	FT	IN	S	FT	IN
E	FT	IN	D4	FT	IN	J	FT	IN	T	FT	IN
F	FT	IN	I-Beam	FT	IN	K	FT	IN	U	FT	IN
						L	FT	IN	N	FT	IN
						M	FT	IN	P	FT	IN

SAFETY LEDGE _____ IN

COVE OFFSET _____ IN

COVE DEPTH _____ IN

Is the Pool Bottom 'BOWLED' or 'DISHED' out? _____

If 'YES', supply additional drawings representing the bottom design.

IMPORTANT!

BEAD

- Yes
- No _____ inch overlap
- Reverse
- Esther Williams (large bead)

PATTERN

Wall Pattern: _____

Floor Pattern: _____

Vinyl Thickness: 20 Mil 28 Mil 30 Mil

SPECIAL INSTRUCTIONS / ADDITIONAL INFORMATION

ALWAYS attach any drawings and details that will help us understand your pool.

Pool Owner Signature _____

DATE _____